



INSTRUCTION MANUAL FOR DISHWASHERS

MDITT31-1 (r.0*)

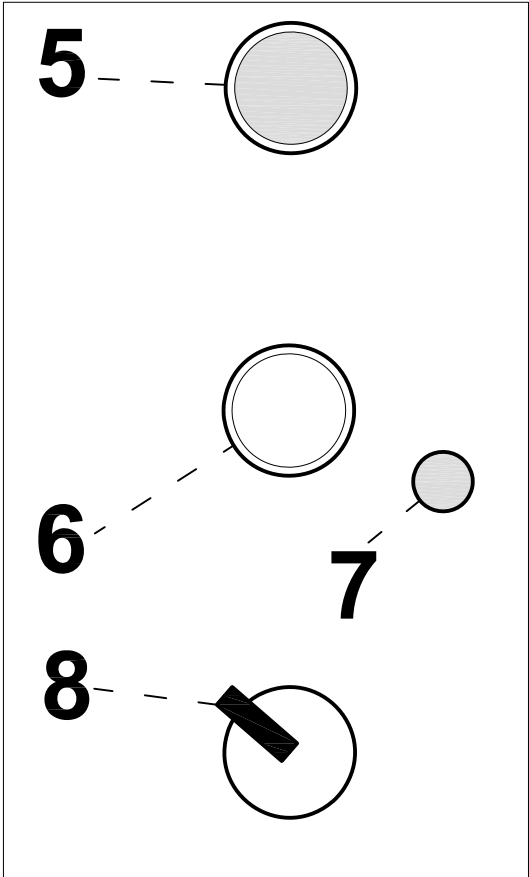
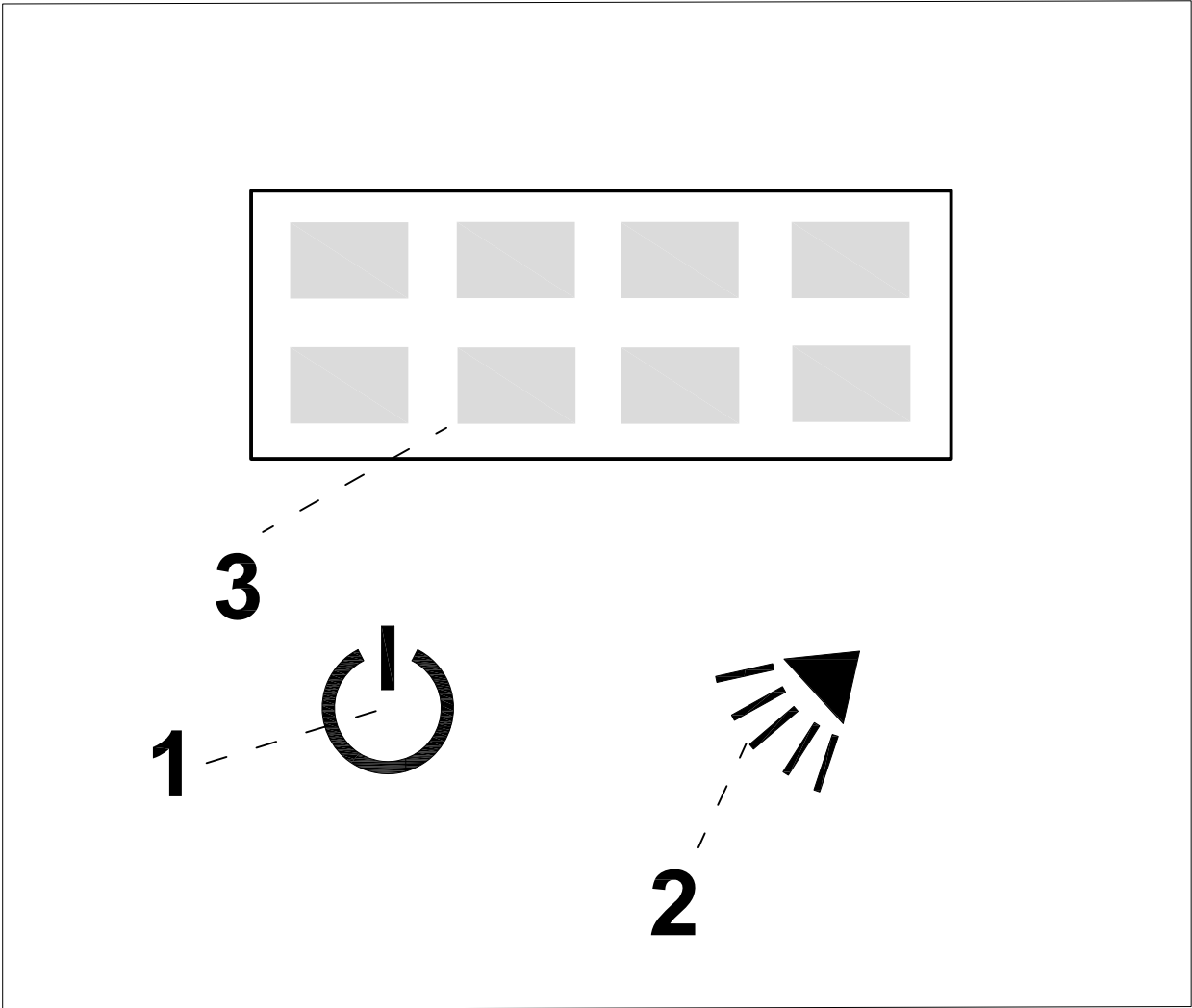

Fig.1

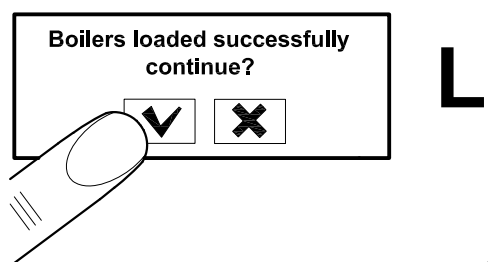
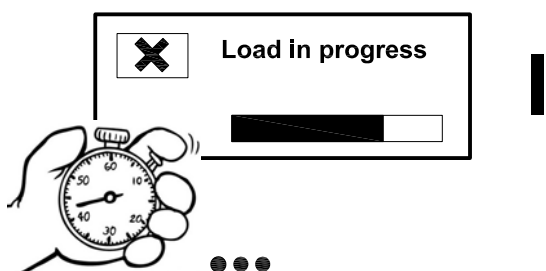
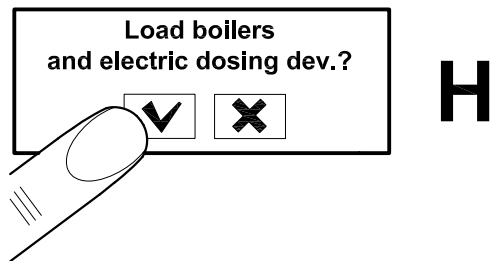
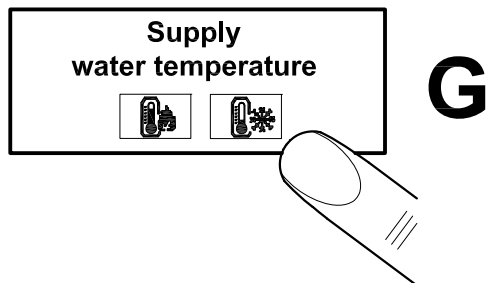
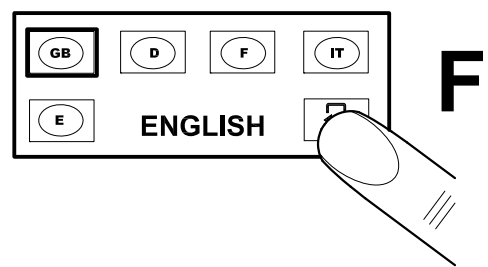
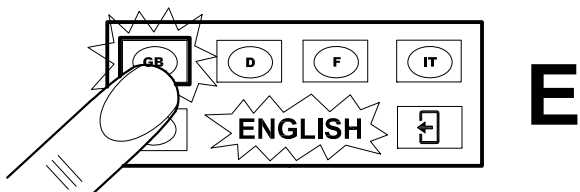
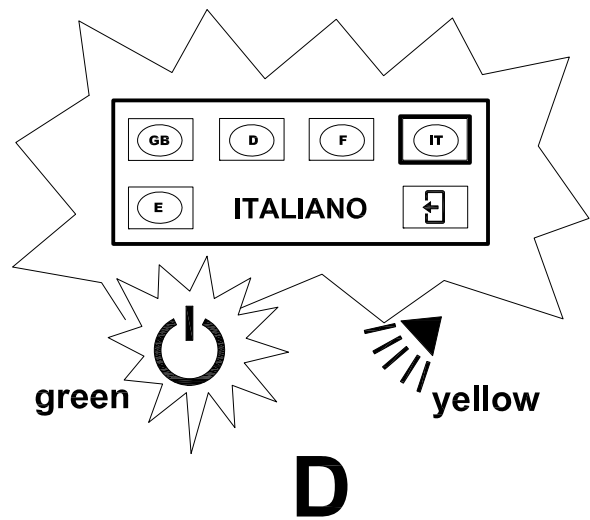
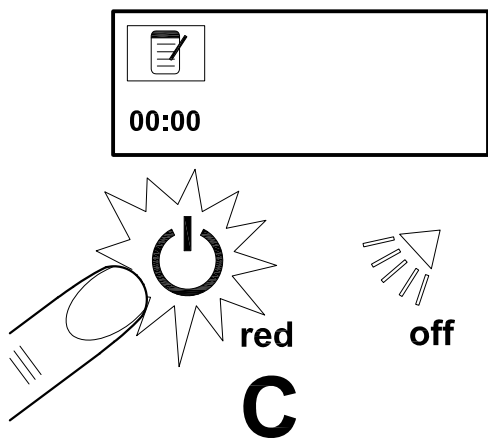
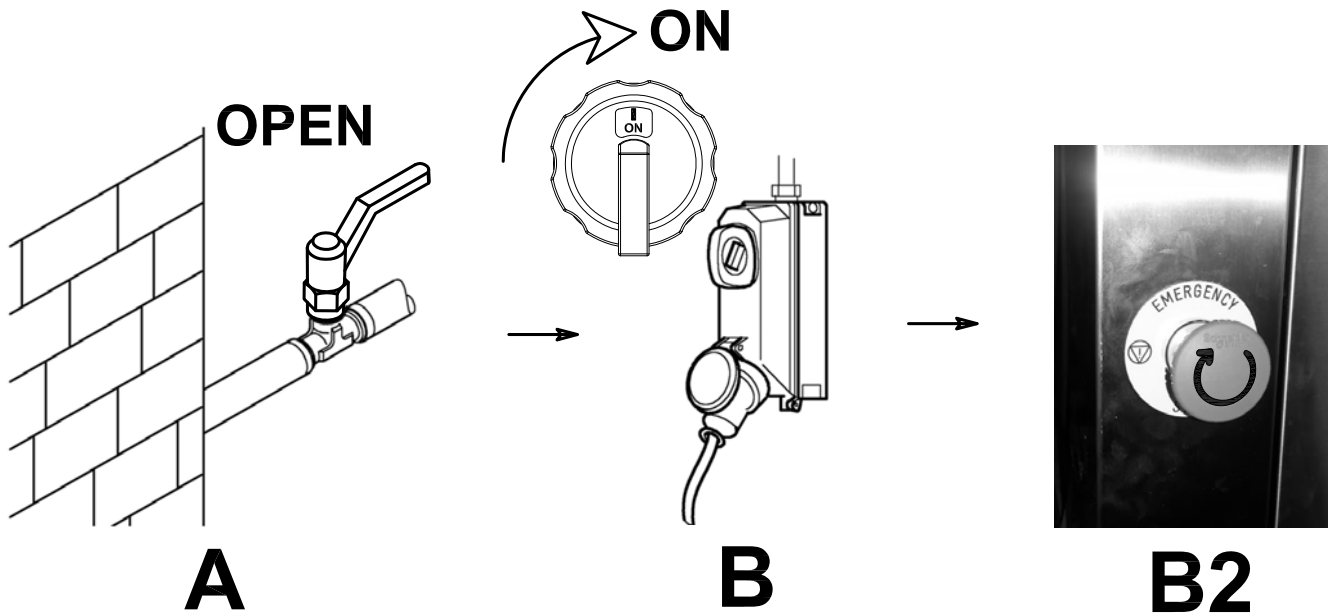

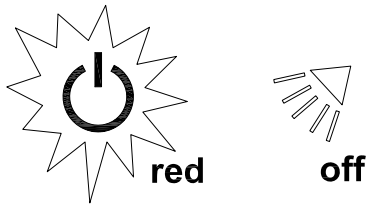

Fig.2

VERSIONE HW & SW
 POW:H-0037_2 F-150612
 DIS:H-0038_2 F-150612
00:00

A1



Wait Please

A



Pronta premere START





B







Fig.3

Pronta premere START

A

B

C

Fig.5

Ready insert basket

A

Ready insert basket



B



Lavaggio attivo

C

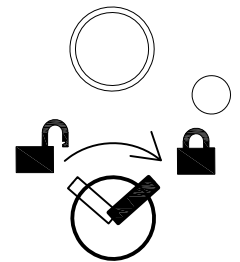
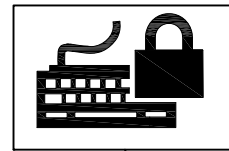
Fig.4



Pronta premere START

Fig.5B

Lavaggio attivo

A

Fig.6

T W2
 +50.0°C
 T B1
 +79.1 °C
 T B2
 +80.3 °C

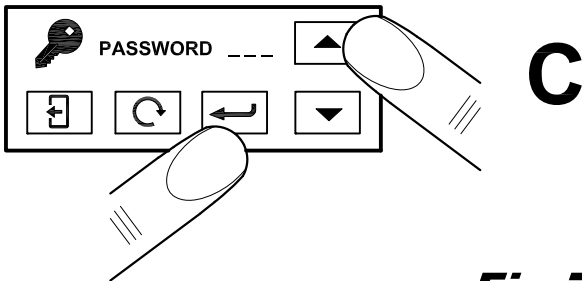
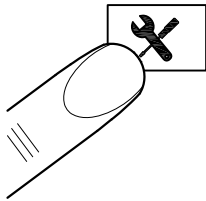
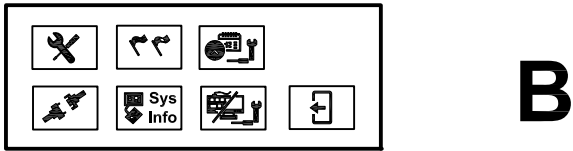
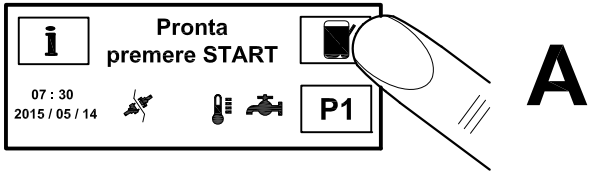

Fig.7

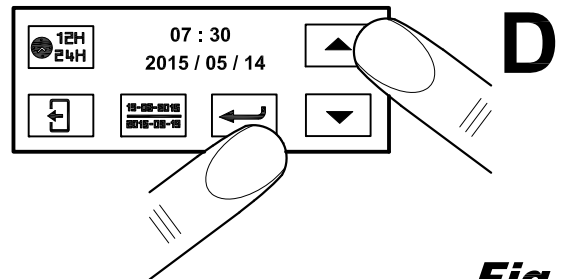
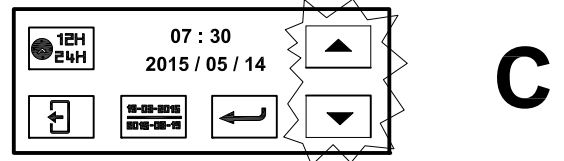
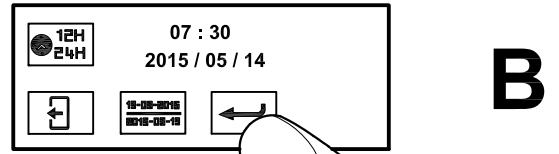
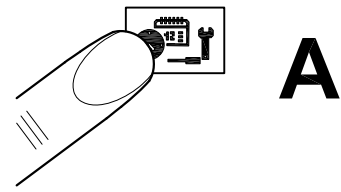

Fig.8

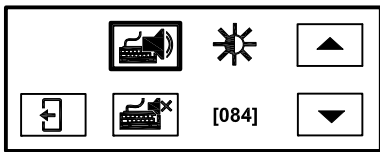
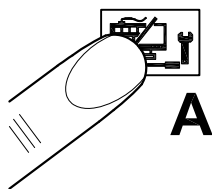

Fig.9

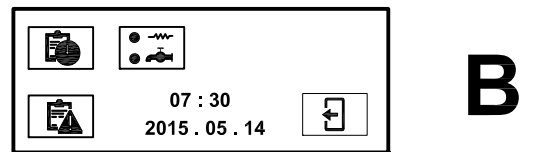

Fig.10

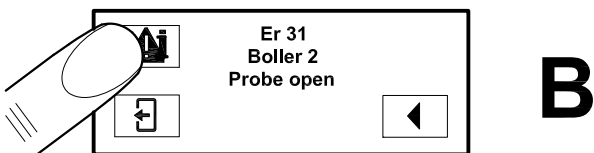
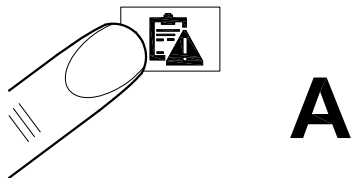

Fig.11

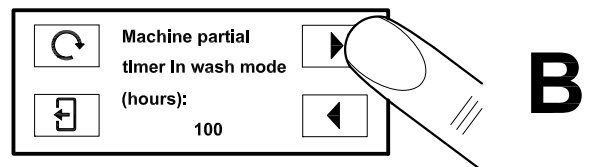
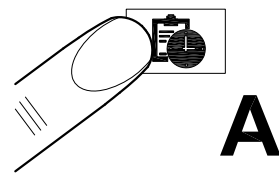
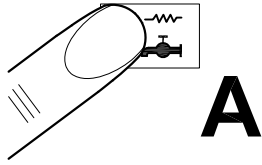

Fig.12



A



B

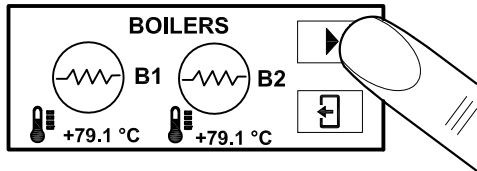

C

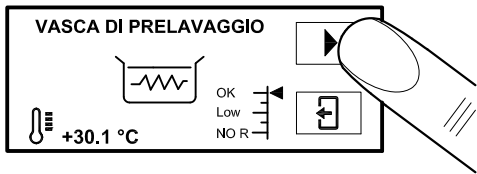

D

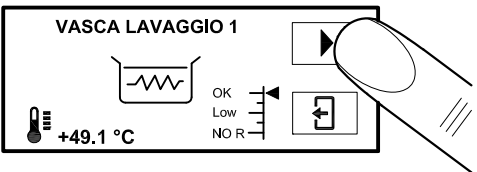

E

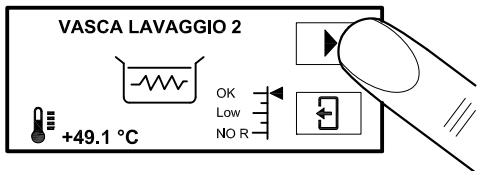

F

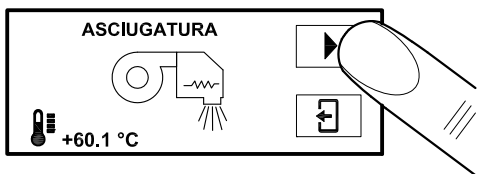

G

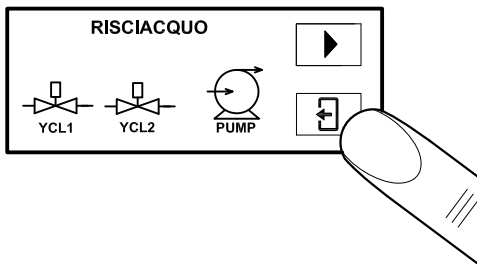

H

Fig.13

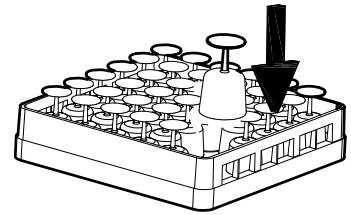
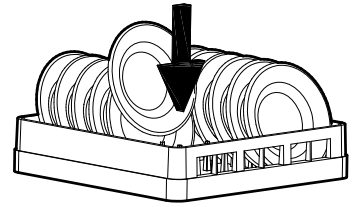

Fig.14



Fig.15

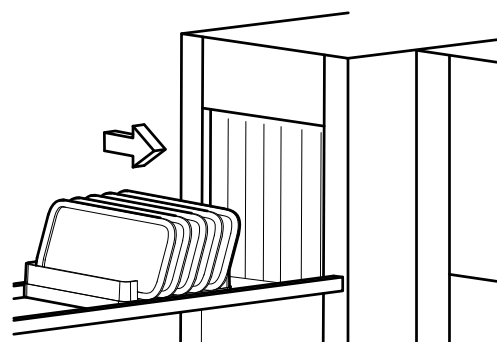
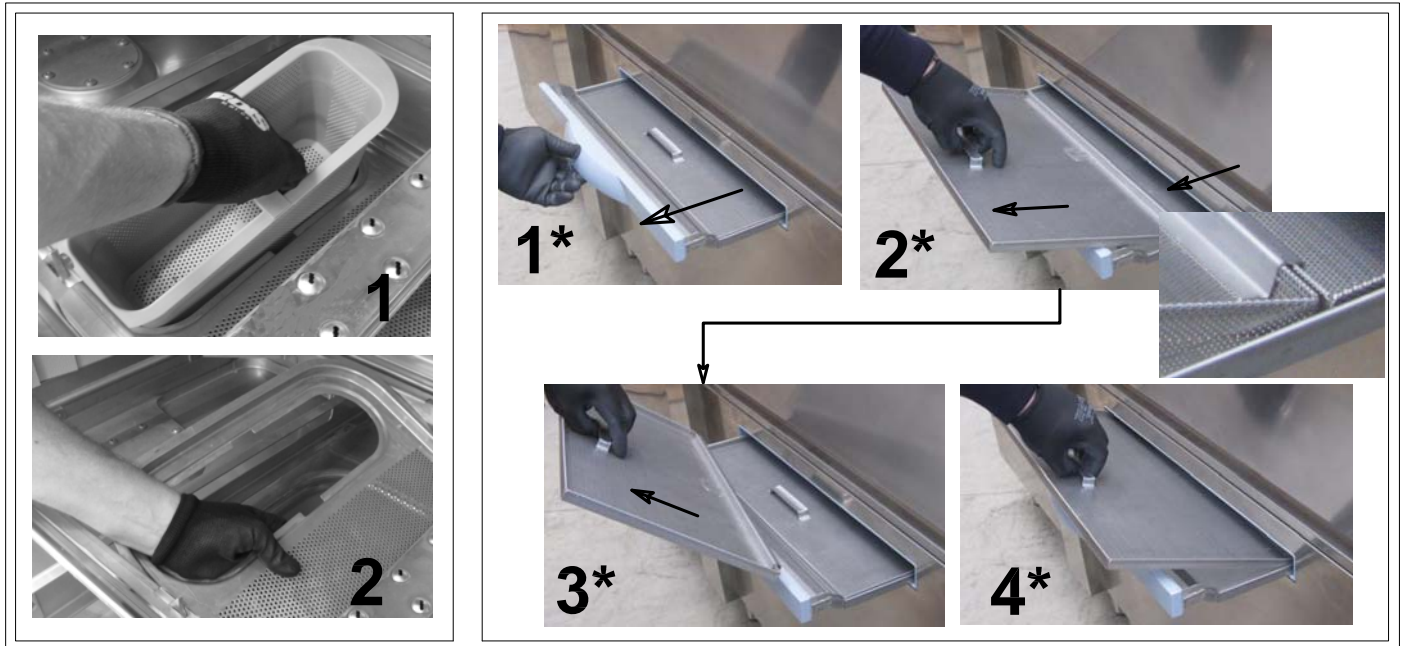
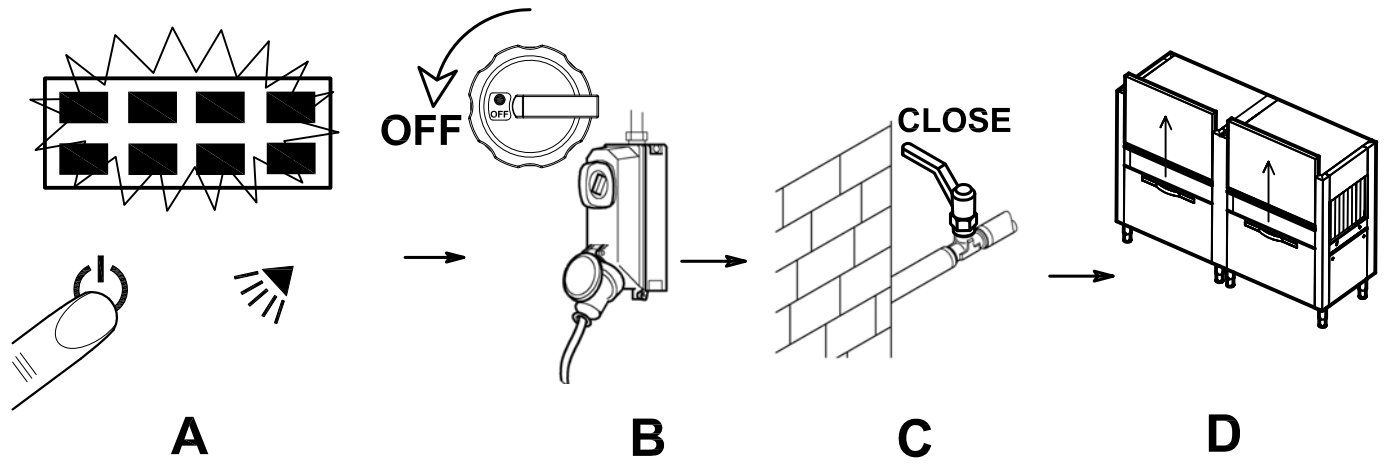

Fig.16



E



F

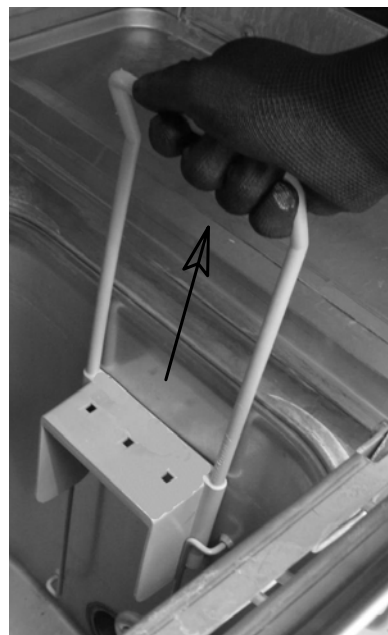

G

Fig.17

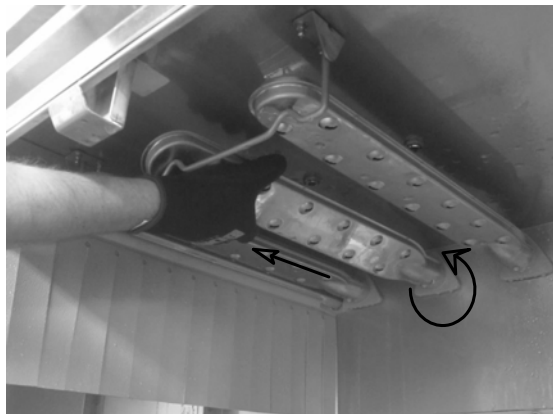
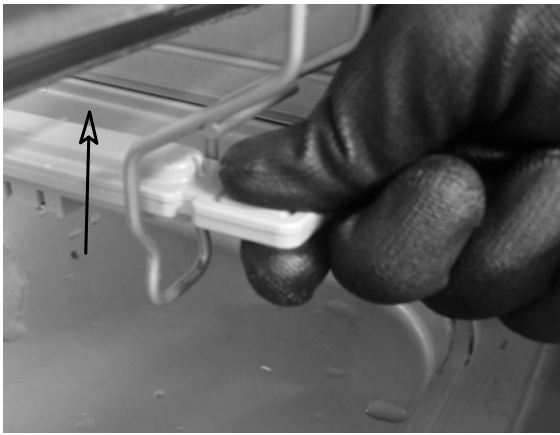

Fig.18

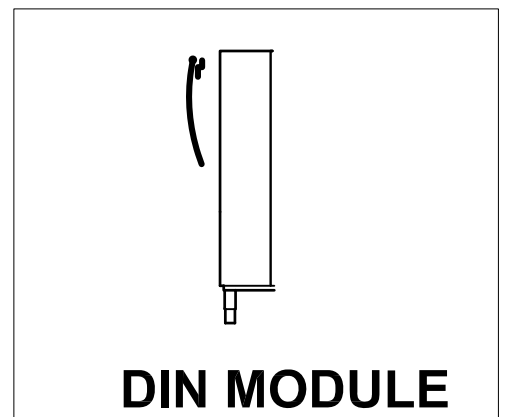
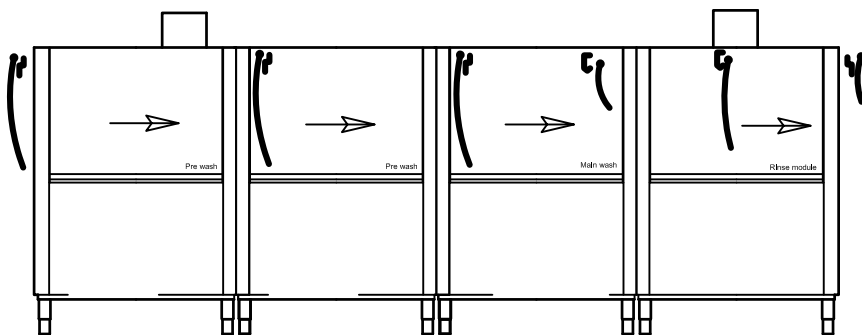
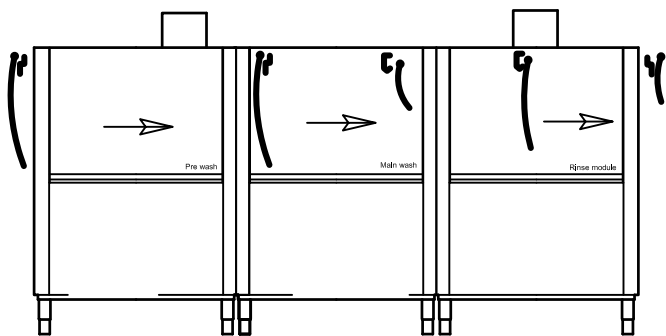
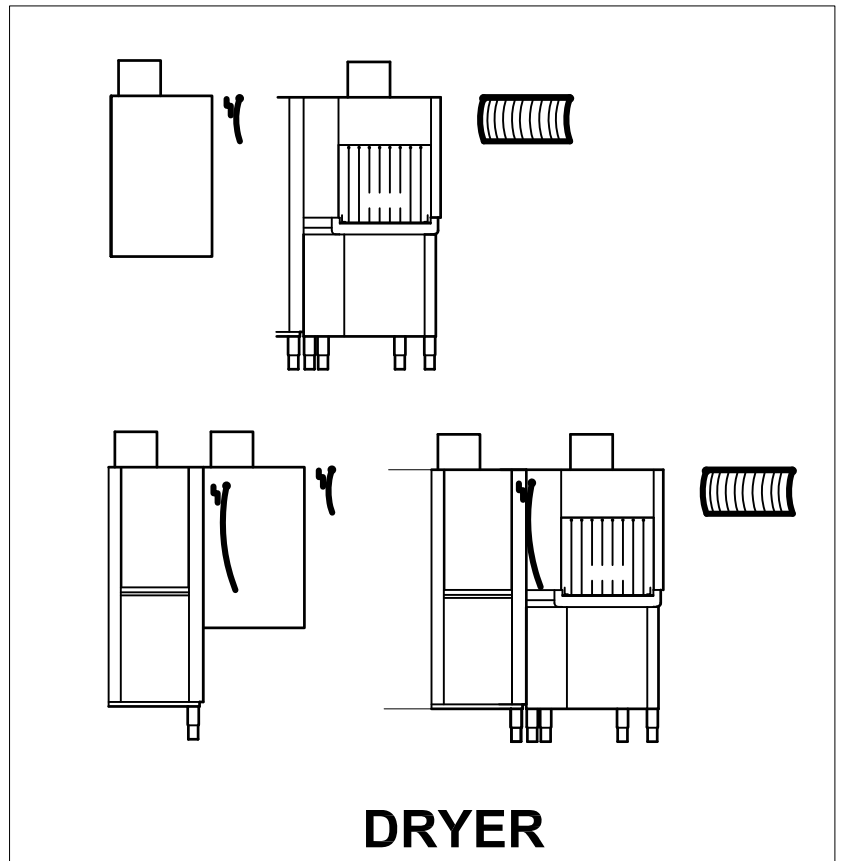
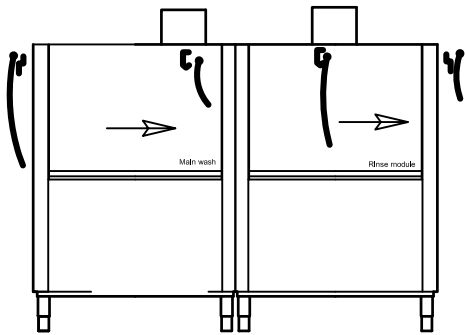

Fig.19

INDEX

CAP 1	RISKS AND IMPORTANT WARNINGS	3
CAP 2	FOREWORD	6
CAP 3	HANDLING AND TRANSPORTING THE MACHINE	6
3.1	TRANSPORTATION AND PACKAGING	6
3.2	HANDLING.....	7
3.3	STORAGE	7
3.4	DIMENSIONS	7
CAP 4	INSTALLATION	7
4.1	HAZARD ZONES	7
4.2	IMPORTANT WARNINGS	8
4.3	ACOUSTIC PRESSURE LEVEL	8
4.4	UNPACKAGING AND POSITIONING.....	9
4.5	ENVIRONMENTAL CONDITIONS.....	10
CAP 5	INSTALLATION	10
5.1	ELECTRICAL CONNECTION.....	10
5.2	CONNECTION TO WATER SUPPLY	11
5.3	CONNECTION TO THE DRAIN NETWORK	12
5.3.1	<i>Wash tank connection.....</i>	<i>12</i>
5.4	CONNECTION OF STEAM HOSES (OPTIONAL)	13
5.5	CONNECTING THE LIMIT SWITCH	13
5.6	INSTALLATION OF DISPENSERS	14
5.8	COMMISSIONING.....	15
5.8.1	<i>First boiler loading</i>	<i>15</i>
5.8.2	<i>Machine equipped with double boiler</i>	<i>15</i>
5.9	CONTROLS	16
CAP 6	MACHINE DESCRIPTION.....	17
6.1	MACHINE DIAGRAM	17
6.2	DANGEROUS POINTS	18
6.3	SAFETY DEVICES	18
6.4	USE ACCORDING TO THE REGULATIONS	18
CAP 7	MACHINE USE	19
7.1	COMMAND DESCRIPTION	19
7.2	SWITCHING THE MACHINE ON	19
7.3	HEATING.....	19
7.4	WASHING.....	19
7.5	WASH PROGRAMS	19
7.6	STOP DEVICE	20
7.7	DISPLAY OF TEMPERATURES	20
7.8	END RUN DEVICE	21
7.9	TURNING OFF AND STANDBY OF THE MACHINE.....	21
7.10	ADJUSTEMENT	21
7.10.1	<i>Adjustement of temperature</i>	<i>22</i>
7.10.2	<i>Dosing devices</i>	<i>23</i>
7.11	DATE AND TIME ADJUSTMENT	24
7.11.1	<i>Time adjustment.....</i>	<i>24</i>
7.11.2	<i>Brightness adjustment and acoustic signal</i>	<i>24</i>
7.11.3	<i>System information.....</i>	<i>24</i>
7.11.4	<i>Connectivity.....</i>	<i>24</i>
7.12	INFORMATION MENU	26
7.12.1	<i>Error messages</i>	<i>26</i>
7.12.2	<i>Operating hours display.....</i>	<i>26</i>
7.12.3	<i>Work functions display.....</i>	<i>26</i>

7.13	MECHANICAL CONTROL PANEL	27
7.13.1	<i>Voltage presence light</i>	27
7.13.2	<i>Exclusion of the touch display</i>	27
7.13.3	<i>Line push Button ON/OFF</i>	27
7.14	SELF-ERRORS DIAGNOSIS	28
7.15	END OF WASHING OPERATIONS	29
7.16	POSITIONING THE DISHES.....	30
CAP 8	MAINTENANCE	31
o	GENERAL RULES	31
8.1	PERIODICAL MAINTENANCE	32
CAP 9	DISPOSAL	33
CAP 10	ENVIRONMENT	33



Read the instruction manual carefully before starting the machine. It contains important information regarding safe installation, use and maintenance. Failure to observe the instructions in the enclosed documentation may compromise appliance safety and immediately voids the warranty.



Cap 1 RISKS AND IMPORTANT WARNINGS

- This appliance is intended solely for the use for which it was designed. Any other use is deemed improper and therefore hazardous.
- The specialised personnel responsible for installing the appliance must adequately instruct the user on its operation and any relevant safety measures, also providing practical demonstrations.
- Keep the machine in perfect working order and always use the various protection devices it is fitted with; ensuring regular maintenance is carried out by professionally qualified personnel. In particular, make sure all the safety devices are periodically inspected by them.
- In case of a fault or malfunction, switch the appliance off, disconnect the power supply, shut off the water and do not attempt to carry out any repairs or intervention directly; request the assistance of an authorised repair technician.
- Only the manufacturer or an authorised service centre with qualified personnel may work on the machine, even in case of malfunction, only using original spare parts.
- Failure to comply with the above may compromise the safety of the appliance.
- Always disconnect or isolate the machine from the power and water supplies before servicing, repairs or cleaning, turning off the system switch.
- **NEVER** use water to extinguish fires on the electrical parts. Use a powder fire extinguisher.
- The machine must **NOT** be used by untrained persons.
- The appliance **CANNOT** be used by children and by persons with reduced physical, sensory or mental capabilities, or lacking in experience and the necessary expertise.
- Children must **NOT** play with the appliance.
- Cleaning and maintenance intended to be carried out by the user must **NOT** be done by children.
- The machine must **NOT** remain switched on when not in use.
- Always turn the machine off at the wall switch when not in use.
- Shut off the water supply whenever the machine is not in use.
- In case of leaks of water or liquids, immediately switch the machine off and shut off the water supply.
- If an appliance of this type is no longer going to be used, make it inoperative by removing the power cable, after having disconnected it from the mains.
- If the machine is not fitted with a plug or other means of complete disconnection with separation of all the contacts, these disconnection devices must be incorporated into the power mains, in compliance with the installation rules.

- If the power cable is damaged, it must be replaced by the manufacturer or an authorised technical assistance service, or in any case by a person with similar qualifications, to prevent any risk.
 - The screw on the appliance marked with the IEC 60417 standard symbol 5021 is the equipotential connection.
 - **NEVER** open the doors of the machine quickly during operation. Wait at least 15 seconds after the motors have stopped.
 - When opening the doors, make sure they are properly attached to their supports.
 - Check that the direction of rotation is as marked on the central moving part. Otherwise contact qualified personnel to reverse the direction of rotation of the whole machine
 - Should the rack conveyor system stop due to the safety device, remove the obstacle that caused the blockage before restoring operation. To retrieve any items that have fallen inside the machine, stop the machine and switch it off.
 - Do not remove the basket before it has completely exited the machine.
 - To avoid the risk of becoming entangled and dragged **keep away** from moving parts if wearing dangling jewellery or very large or wide-sleeved garments.
 - **NEVER** use the machine without the protection devices arranged by the manufacturer.
 - Make sure all items being washed are dishwasher safe.
 - **NEVER** use the machine to wash objects of type, shape or material not guaranteed as machine washable or not perfectly intact.
-
- **NEVER** use the appliance or any of its parts as steps or a support for people, property or animals.
 - Do not use the machine as support surface for any objects and/or tools.
 - **NEVER** overload the open door of **front-loading machines**; it is designed to only support the basket loaded with dishes.
 - **NEVER** place bare hands in the washing solutions. If water containing detergent accidentally comes into contact with eyes, rinse with plenty of clean water and seek medical advice.
 - **NEVER** overturn the machine after it has been installed.
 - Do not install the dishwasher near heat sources over 50°C.
 - **NEVER** leave the dishwasher exposed to the weather (rain, direct sunlight, etc.)
 - The dishwasher must **NOT** be installed outdoors without adequate cover.
 - Do not obstruct the air inlet or outlet grilles.
 - Do not operate the machine without filters.
 - Never start a wash program without the overflow, if foreseen.
 - **NEVER** place magnetic objects near the machine.

- Before connecting the appliance, make sure the details on the data plate match those of the mains power and water.
- Check that the electrical capacity of the system is adequate for the maximum power absorbed by the appliance. If in doubt, contact a qualified person who must check that the cross-section of the system cables is suitable for the power absorbed by the appliance.
- The incoming power supply cables (not provided) to the main switch must be indicated with the appropriate danger warnings.
- The appliance power supply cable must be **H07RN-F** type.
- The installer technician must check the efficiency of the “**earth**” as required by the applicable safety standards. This fundamental safety requirement must be respected; if in doubt, request a thorough inspection of the entire system by professionally qualified personnel.
- At the end of testing, the installer technician must issue a written declaration regarding correct installation and testing according to the applicable regulations and highest standards.
- **DO NOT** modify the protection devices. Remove them only if the machine is stopped and disconnected from the power supply; reinstate them before reconnecting it to the power supply.
- After disconnecting the power supply, only qualified personnel may access the control panel.
- **DO NOT** change the position of or tamper with the machine’s parts, as this could compromise its safety.
- **DO NOT** use dispensing devices or other devices not prescribed by the manufacturer, which may alter the machine’s safety or operating characteristics.
- Noise pressure level according to EN ISO 4871
 - LpA Max = 68.0db Kpa=2.5db for versions without drying
 - LpA Max = 69.5db Kpa=2.5db for versions with drying
- Max inlet water temperature: 65°C
- Max inlet water pressure: 4bar (400kPa)
- Appliance designed for permanent connection to the water supply
- For cleaning operations, carefully follow the instructions provided in the manufacturer’s handbook.
- The appliance must **NOT** be cleaned with steam or water jets.
- Only use anti-foaming detergents specific for dishwashers, in the doses recommended by the manufacturer according to the water hardness and tank capacity.
- Never use acidic or corrosive products to clean the machine or to wash dishes.
- Never use products containing chlorides in concentrations above 50 ppm as a dishwasher detergent or to clean the machine.
- Never use steel wool pads, steel brushes or shavings to clean the stainless steel.

- In order to protect the environment, avoid the use of corrosive or pollutant products and do not exceed the recommended doses.
- Personnel in charge of handling the dishes must strictly follow the applicable hygiene regulations after the wash.
- Remember that the machine must **NEVER** be operated without the special protection curtains: at entry, exit, and intermediate positions.
- Max unloading height
 - On the ground in versions with overflow
 - Maximum height 1 m in versions with drain pump

Normal operating conditions

Ambient temperature : 40°Cmax /4°Cmin (average 30°C)
 Altitude : up to 2000 metres
 Relative humidity : Max 30% at 40°C / max 90% at 20°C

Cap 2 FOREWORD

Warnings:

Carefully store all the documents near the appliance. Hand them to the technicians and workers in charge of use and make sure they are kept well preserved over time, at a safe location, ideally with copies for frequent consultation.

The operator must read, understand and learn the present manual before carrying out any operation on the device.

This piece of equipment is destined exclusively to the professional washing of tableware for large numbers of people. Therefore, its use and maintenance are only to be carried out by well-trained personnel, committed to following the manufacturer's instructions.

Warranty:

The manufacturer declines all responsibility and warranty for damages to things or persons derived from failure to follow the instructions provided herein or from improper use of the machine.

Failure to follow the indications contained in the attached documents may compromise the safety of the device and cause the warranty to be immediately annulled.

Installation and repairs carried out by unauthorised technicians, or the use of non-original spare parts, will cause the warranty to be immediately annulled.

Cap 3 HANDLING AND TRANSPORTING THE MACHINE



3.1 Transportation and packaging

The machines can be transported in two manners:

- on lorries
- in containers

Both situations require the same kind of packaging.



3.2 Handling

- The machines must be handled with care, using a forklift truck or a hand pallet truck.
- The hoisting points are marked on the machine by adhesive labels.



- During transportation, it is forbidden to remain near the machine, as it may tilt and cause serious harm to persons nearby.
- Accidents may involve impact, entanglement, and trapping by the machine during handling and storage of the machine itself.

3.3 Storage

Storage methods for materials must include pallet, containers, conveyor belts, vehicles, lifting equipment and devices suitable for the prevention of damages caused by vibration, impact, abrasion, corrosion, temperature or any other condition that may occur. The parts stored must be periodically inspected for deterioration.

Storage:

Transportation and deposit: between -10° C and 55° C, with peaks of up to 70° C (max 24 hours)

3.4 Dimensions

The machines of the rack conveyor line are available in various models, whose layouts are attached to this document, including the dimensions of each machine.

Cap 4 INSTALLATION

4.1 Hazard zones

Definition of hazard zones and how (see fig. on next page) they are indicated, plus a general description of the protection measures adopted.



Risk of entanglement and dragging
 - On the conveyor



Thermal hazard
 - on the doors accessing the wash / rinse section
 - on the drying chamber walls.
 - on the boiler during machine installation and maintenance.
 - Inside the machine for removal of the wash tank overflow.



Electrical shock hazard
 - electrical control panel
 - electropumps
 - fan
 - electrical elements



Slippery floor hazard
- On floor wet from splashes and steam condensation

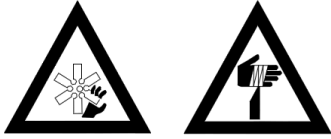

Shearing hazard
- on the fan of the extraction unit
- inside the machine on sheet metal sheet and sharp profiles

The machine is equipped with casings that limit access to the interior and to moving parts; these are fixed to the machine with screws.

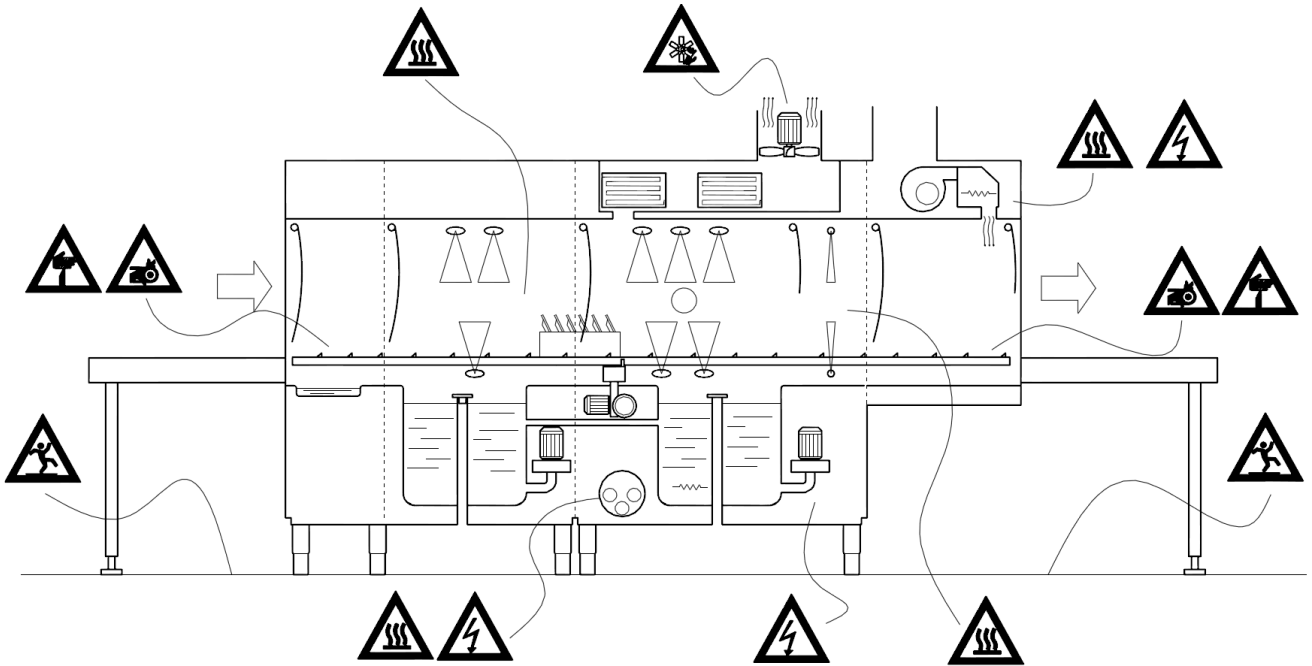

4.2 Important warnings

Before carrying out any operations inside the wash chamber with the machine switched off which require removal of the tank filters and/or the wash and rinse arms, wear protective gloves with a blade cut-resistance of no lower than 3 in accordance with standard EN388.

4.3 Acoustic pressure level

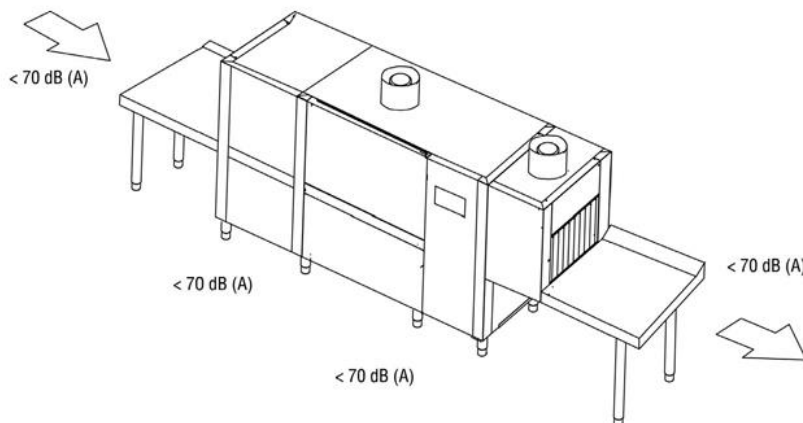

4.4 Unpackaging and positioning

When the machine is received, open the packaging and check the machine and its accessories for damage occurred during transportation. If any damages are detected, immediately report to the transportation company and do not proceed with installation: seek the assistance of qualified, authorised personnel.

The manufacturer cannot be held responsible for any damage occurred during transportation.

Packaging elements (plastic bags, Styrofoam, strips of wood, nails etc) must be kept away from the reach of children, as they are potentially hazardous.

Position the machine according to the indications supplied by the general installation layout, supplied separately, making sure its position is correct regarding maintenance needs.

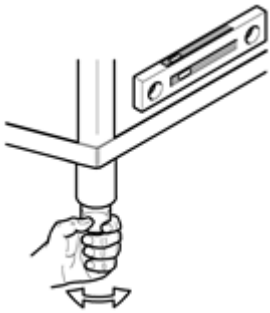

Screw the feet to the supports and place the machine in its proper position. Adjust the height of the feet to level the machine. As these machines are long, use a spirit level.

Warning:

While positioning the machine, do not drag it on the floor, as this may damage its structure.

The floor must be dimensioned taking into consideration the overall weight of the machine. The floor must be levelled.

4.5 Environmental conditions

- Environmental temperature: 40° C max/4° C min (average: 30°C)
- Altitude: up to 2,000 metres
- Relative humidity: Max 30% at 40° C/max 90% at 20° C

Cap 5 INSTALLATION

5.1 Electrical connection

- **Warning! Installation must be carried out only by specialised technicians!**
- Before connecting the equipment, make sure that both the voltage and frequency of the mains power supply correspond to those indicated on the data plate affixed to the side panel of the machine.
- To connect the machine to the mains power supply, use only H07RN-F type power supply cables with a conductor cross-section appropriate for the maximum absorption indicated on the data plate and as indicated in the table below.
- Take care when laying out the cable to observe the minimum bend radius indicated by the cable manufacturer.

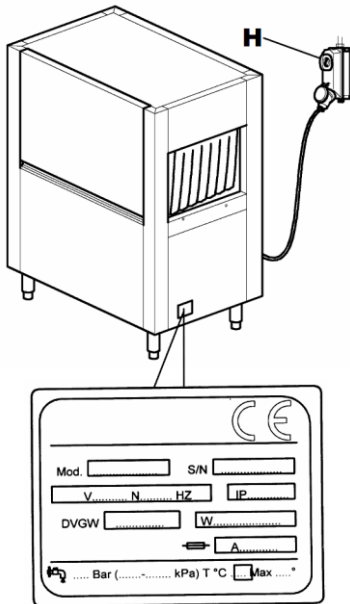

H07RN-F		
Current (A)	Cross-section (mm ²)	Maximum length (mm)
40	10	5000
50	16	
63	16	
80	25	
100	35	
125	50	

- The machine must be connected to the power supply by means of a type "C" dedicated automatic omnipolar switch in compliance with safety regulations in force, or alternatively with a disconnect switch having fuses with 3 mm minimum opening distance between contacts. The above-mentioned switch, not supplied with the machine, must wall-mounted at an easily accessible point, at a height between 0.6 m and 1.70 m.
- Before connecting the machine to the power supply, make sure the power is switched off at the mains.
- Remove the front panel and the cover of the electrical board by removing the screws.
- Feed the power cable through the cable gland on the back of the machine.
- Connect the cable to the terminals on the board, as indicated in the wiring diagram attached.
- If the Neutral and Earth cables are incorrectly connected, this can result in irreversible damage to the machine, and the warranty may be invalidated!
- Check that the cables on the contactors, thermal protections etc. are properly tightened, as the screws may have worked loose during transportation.

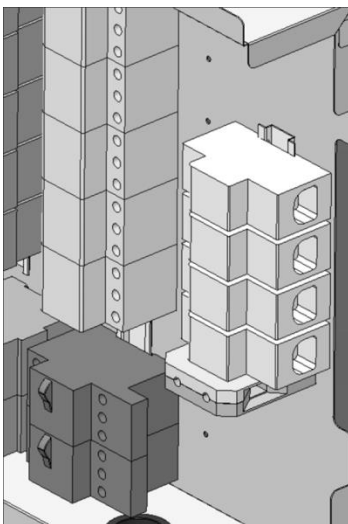

- Refit the front cover panel and the control panel using the screws provided.

- The power supply cable must not be stretched or crushed during normal operation or routine maintenance.
- The appliance must also be connected to an equipotential system with a screw marked with the symbol .
- The equipotential cable must have a cross section of 10 mm².



Do not use multi-sockets, adapters, cables of an inadequate cross-section or type or with extensions not conforming to established electrical installation regulations.

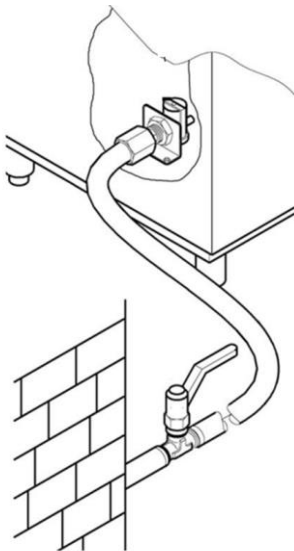

5.2 Connection to water supply

Prepare the installation site according to the installation diagram attached.

Before connecting the appliance, make sure that there is a gate valve installed between the mains water supply and the machine, allowing the water supply to be shut off in case of need or when carrying out repairs.
In addition, make sure that the water supply flow rate is no lower than 20 l/min.

Warning!

- Make sure that the temperature and pressure of the mains water supply are within the range of pressure and temperature values indicated on the technical data plate.
If they are not, it will not be possible to achieve suitable water flow rates and temperatures for proper rinsing.

If the local mains water is harder than the value indicated on the data plate, we recommend installation of a water softener upline of the machine's solenoid inlet valve.

If the water has a very high residual concentration of high conductivity minerals, we recommend installation of a demineralisation system calibrated to achieve residual hardness as indicated in the table below.

	Characteristics		Min	Max
Hardness	French degrees	f	5	10
	German degrees	°dH	4	7.5
	English degrees	°e	5	9.5
Mineral residues (TDS)	Parts per million (20°C)	ppm	70	
		mg/l	70	

Warning!

- Machines intended for use with desalinated water or in any case with water having a high concentration of sodium chloride, must be expressly ordered, as their construction requires the use of specific materials.

5.3 Connection to the drain network

The machine is supplied complete with corrugated drain hoses and connectors for each tank to be used in the event that the drainage water is to be channelled into a single drain outlet equipped with a syphon as described in the following paragraph.

These drain hoses are not recommended for use in the event of direct drainage into a sump.

5.3.1 Wash tank connection

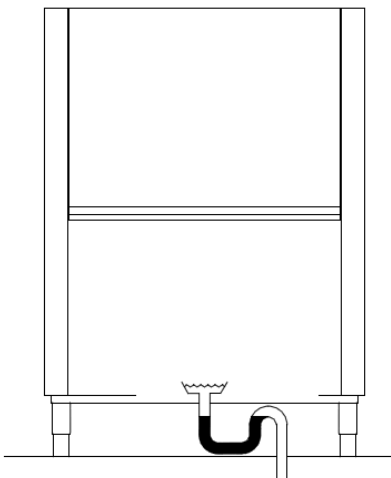

- Rack conveyor dishwashers operate continuously, which means they require particularly efficient and functional drainage systems.
- For the position of drains on each tank and the exact dimensions, refer to the installation diagram enclosed with each machine.
- Connect the machine's drains to the mains drainage using hoses designed to withstand a continuous temperature of 70°C, using the connectors supplied if necessary.
- The drainage system must always include a siphon, even in the case of direct drainage into a sump as illustrated in the figure
- In the case of multiple wash tanks, they may all be connected to a single siphon
- The height from the ground of the siphon "H" must not exceed the height B of the drain pipe as illustrated in the figure.

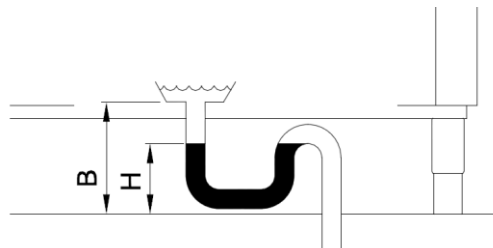
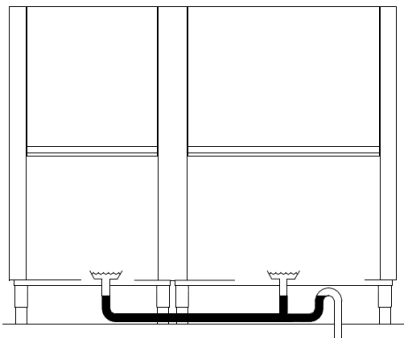

5.4 Connection of steam hoses (optional)

The machine vents steam during operation and it is therefore advisable to install a forced air extraction hood above it (1500-3000 m³/h)

Alternatively, on request the machine can be supplied ready-fitted with a steam extraction or recovery system.

In the latter case, steam can also be channelled directly outside the installation space by means of a flue consisting of suitable stainless steel ducting with a diameter of 250 mm.

Warning!

- The drying module flue is designed to close the motor housing and must not be connected to any hose.
- Do not use fully demineralised water in machines with a recuperator fitted with heat recovery batteries with copper pipes. In this case, request the version with batteries with stainless steel pipes.

5.5 Connecting the limit switch

The machine **MUST** be fitted with a limit switch before use.

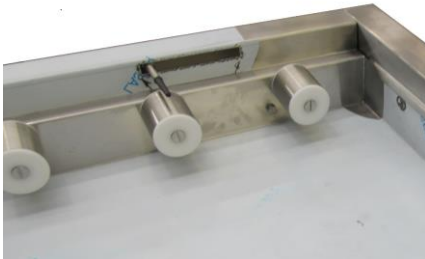

- The limit switch must be installed on the outfeed table.
- The switch must be mechanically fixed to the machine in such a way as to guarantee its operation
- We recommend using a limit switch of the type with lever activation with washer or spring, to increase the contact surface and reduce the effect of mechanical contrast.
- Checks must be carried out to verify proper functioning of the limit switch with all the baskets in use on site.
- It must have a protection level of at least IP55
- The limit switch must be in positive mode (contact normally closed)
- It must have a minimum rated capacity of 240V 1.5A
- Recommended mechanical duration 10,000 K cycles.



5.6 Installation of dispensers

The machine is equipped with specific outputs for rinse aid and detergent dosing devices. Connect the dosing devices as shown in the wiring diagram to ensure the correct operation of the machine.

The rinse aid and detergent must be dosed by the automatic dispensers.

The amount of both of these products is established by the installation technician based on local water hardness, and the technician also calibrates the dispensers themselves.

For the initial filling of the dosing circuit and the relative settings, see the "Settings" paragraph.

- The level of liquids in the containers must never be allowed to reach empty.
- The dispensers must never be filled with corrosive or contaminated products.
- Chlorine-based products must not be used under any circumstances, as they cause the formation of chloride, which in concentrations above 50 ppm can lead to corrosion
- It is not advisable to dispense the products manually.
- For any other installation, refer to the wiring and installation diagrams enclosed
- The machine cannot be fitted with multi-voltage dosing devices and/or dosing devices with absorption higher than 5A per output.

If you wish to use this type of dosing device, it must be connected to an external 16A relay

WARNING!

- The use of detergents containing chlorides in a concentration exceeding 50 ppm can lead to corrosion of the machine's stainless steel structure.

5.7 Installation of protection curtains

The machine is equipped with protection curtains to separate the various sections of the machine.

For the assembly diagram, see figure 19.

5.8 COMMISSIONING

5.8.1 First boiler loading

Reference figure 2

- Open the supply water gate valve (fig.2/A)
- Connect the electric power supply using the master switch (fig.2/B)
- The line key (1) lights up in red (fig.2/C)
- Press the line key (1) to switch the machine on (fig.2/C)
- The line key (1) turns green and the display shows the icons of the various languages that can be selected (fig.2/D)
- Press the icon of the desired language directly on the display (fig.2/E)
- The icon of the program selected is highlighted in the box and shown on the display (fig.2/E)
- Confirm the selection by pressing the exit icon (fig.2/F)
- Select the water supply temperature using the range indicated successively (fig.2/G)



Cold water (10°C → 50°C)



Hot water (50°C → 65°C)

- Press the confirm icon to activate the boiler load procedure (and dosing devices if envisioned); pressing the X key the procedure is annulled (fig.2/H)
- The machine starts to load the boiler automatically (and dosing devices if installed), showing the time passed and the residual time on the display (fig.2/I)
- When the display shows the boilers loaded successfully message, press the confirm key and the machine is ready to be switched on. (press the “X” key to annul the loading process) (fig. 2/L)

5.8.2 Machine equipped with double boiler

Reference figure 12

For versions equipped with a second boiler, after following the instructions given in the paragraph above, proceed as follows to activate the heating of the elements.

- Disconnect the power supply using the main switch (fig.12/A)
- Remove the panel under the rinse section (fig.12/B) to access the electrical control panel
- Remove the cover of the control panel and access the terminal board (fig.12/C)
- Activate the electrical element by connecting the two terminals indicated in figure 12/D with the wire supplied

Refit the electrical control panel cover and the panel.

5.9 Controls

- Make sure that the level of water in the washing tank, once filled, is 1-2 cm below the overflow level.
- Make sure that the temperature of the washing and rinsing tank is in accordance with the settings.
- Check the dispensers for proper function.
- Make sure the rinsing economiser is working well: it must start dispensing hot water as soon as a basket arrives beneath the rinsing jets, and make the hot water flow stop when the basket moves away.
- Make sure the limit switch is working. The switch must block the functioning of the advancement motor and of the pump whenever a basket reaches the end of the plane. Once the basket is removed, the functioning must resume.
- Check the rotation direction of the pumps. If they are turning in the opposite direction, invert the two phases of the power supply cable.

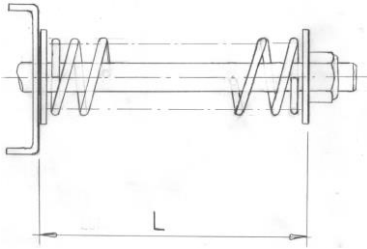

- Check the regulation of the mechanical safety system of the conveyor, which must be adjusted taking into account the overall length of the machine and of the output tables measured by themselves. A full load of baskets full of plates should not block the advancement of the conveyor. To make the regulation, turn the screw on the bracket that supports the conveying motion unit. The advised L length must range from 60 to 75 mm (see figure). Please contact your assistance centre for complex applications.

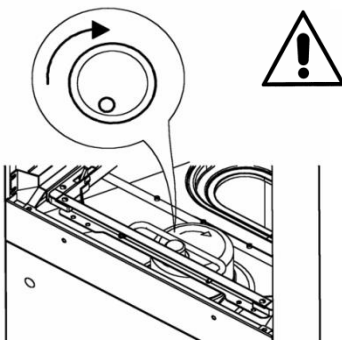

- Make sure that the rotation direction corresponds to the figure and to the central motion of the conveyor.

WARNING: The mechanical safety will not work efficiently if the rotation direction is incorrect.



Failure to carry out these checks will automatically annul the warranty.

END OF INSTALLATION

- The installation technician must inform the manufacturer in case of functioning and/or safety anomalies observed during the initial testing.
- The machine can only be used once installation is complete.
- The technician must issue a declaration of work carried out according to the rules of the trade and to the laws in force.

Cap 6 MACHINE DESCRIPTION

6.1 Machine diagram

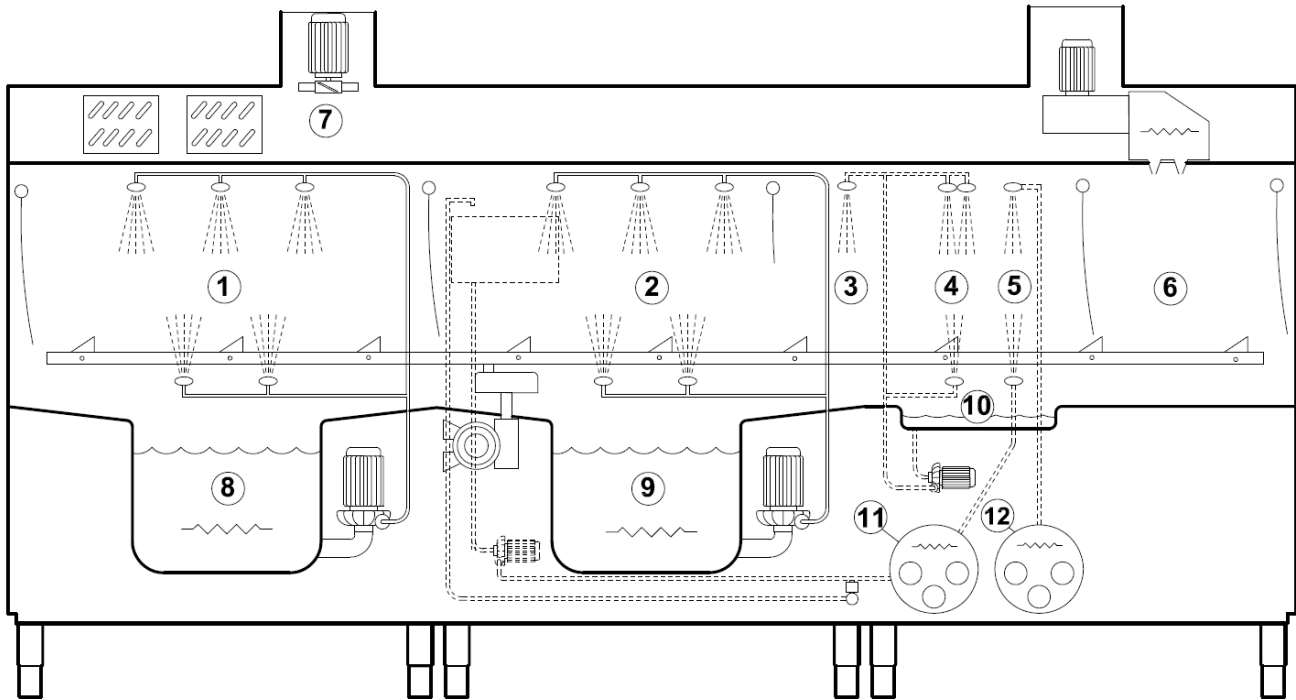

- | | | |
|-----------------------|--------------------------------------|-----------------|
| 1 Pre-wash chamber | 5 Final rinsing chamber | 9 Washing tank |
| 2 Washing chamber | 6 Drying chamber | 10 Rinsing tank |
| 3 Pre-rinse chamber | 7 Steam extraction and recovery zone | 11 Boiler |
| 4 First rinse chamber | 8 Pre-wash tank | 12 Boiler |

Conveying belt washing machines are manufactured with high-quality materials: AISI 304 stainless steel for the washing tanks and stainless steel for the remaining parts.

- In section 1 (pre-wash), the dishes are submitted to an initial removal of dirt.
- In section 2 (wash), the dishes are actually washed.
- Rinsing takes place in sections 3-5.
- The dishes are dried in section 6.
- In section 7, steam is extracted or heat is recovered.
- The baskets are automatically conveyed through the sections thanks to a lateral conveyor.



6.2 Dangerous points

A dangerous point or dangerous area of the machine is an area in which accidents may occur in case of failure to follow the instructions.

- If the conveyor stops during regular functioning, press the line button. Only restart the machine once the cause of the blockage has been identified and removed.
- It is forbidden and very dangerous to access the internal part of the machine from the entrance or exit of the conveyor when the machine is on and in motion.
- It is forbidden and very dangerous to make repairs to the conveying system and to the electric users when the machine is working.
- It is forbidden to use the machine without the surveillance of an operator.
- Do not submerge your hands in the water in the tanks.
- It is forbidden to access the switch to deactivate or activate the machine with wet hands.
- It is absolutely forbidden to access the internal part of the electric box.

6.3 Safety devices

- On the doors there are magnetic switches that interrupt pre-wash, wash, rinse and basket conveying, when opened.
- Protection against unexpected start-up. If the machine accidentally stops due to lack of electricity, it will not resume automatically when the power returns.
- Thermal protections for electro-pumps and motors, guaranteeing their integrity in case of short-circuit and overload.
- Magneto-thermal protections or fuses for each heating element, protecting elements from the dangers of short-circuits and overload.
- Boiler safety thermostat. In case of malfunctioning of a thermostat for temperature control, a second safety thermostat will intervene and interrupt the functioning of heating elements.
- Safety microswitch on the conveyor. If the conveying stops due to accidental causes, the microswitch installed near the support of the motor reducer will interrupt the conveying function.
- Safety door stop. When the doors are opened, the hooks prevent them from falling if a spring should break.
- Low-voltage commands.

6.4 Use according to the regulations

- Conveying machines are expressly designed to wash dishes, glasses, cups, flatware and similar items together with the basket in which they are placed. Any other use is considered to be not in accordance with the regulations.
- It is imperative to respect the manufacturer's safety, use and maintenance regulations.
- It is imperative to respect the suitable regulations to prevent accidents, and further acknowledged safety technique regulations.
- The machine must only be used by personnel suitably trained to avoid hazards.
- The machine must only be used with original manufacturer's accessories and spare parts.

Cap 7 MACHINE USE

7.1 Command description

With reference to fig. 1

1	LINE ON/OFF KEY	3	INFORMATION DISPLAY
2	START/STOP KEY	4	EMERGENCY SWITCH
5	TOUCH LOCKED DISPLAY LIGHT	6	LINE BUTTON ON/OFF
7	VOLTAGE PRESENCE LIGHT	8	TOUCH DISPLAY LOCK SELECTOR

7.2 Switching the machine on

Reference figures 2 and 3

- Open the supply water gate valve (fig.2/A)
- Connect the electric power supply using the master switch (fig.2/B)
- The line key (1) lights up in red and the display shows the system files (fig.3/A1)
- Re-enable the emergency switch (4) by turning it clockwise if activated.
- Press the line key (1) to switch the machine on (fig.2/C)
- The line key (1) turns green and the key (2) has a fixed yellow light.
- The machine starts loading and the display shows the animated icon of the tap and the wording **“Wait please”** (fig.3/A)
- On reaching the correct level, the display shows the alternating **“Press start”** and **“insert basket”** message. (fig.3/B)

7.3 Heating

Reference figure 4

- When loading has been completed, the machine starts heating automatically
- During heating, the display shows the animated thermometer icon (fig.4/A)
- As soon as the temperatures set have been reached, the key (2) turns to a fixed green light (fig.4/B)

7.4 Washing

Reference figure 4

- To start the wash, just insert a basket into the entrance of the machine until it attaches to the basket drive system or, alternatively, press the key (2)
- The display shows the "washing active" message.
- During heating, the display shows the animated plate basket icon (fig.4/A)

7.5 Wash programs

Reference figure 5

- The wash programs selection menu can be accessed, by pressing the key in the bottom right of the display. (fig.5/A)
- Press the icon of the desired program directly on the display (fig.5/B)
- The icon of the program selected is highlighted in the box and shown on the display
- Confirm the selection by pressing the exit key (fig.5/C)
- A different program can be selected during washing, only after the key (2) has been pressed.
- The following programs can be selected:



High capacity
indicated for fresh light soiling.



P2
General purpose
general use program.



P3
Prolonged contact
assures a contact time of 120" in compliance with the DIN 10534 Standard



P4
Glasses
When this program is selected, a system that lowers the boiler temperature to 65 °C is started automatically when the first basket of glasses transits under the rinse. There are no stand-by times (requires the appropriate use of baskets measuring 50x50 cm)



P5
Intensive
for difficult to remove dirt, with washing temperature taken to 63 °C

7.6 Stop device

The machine has an emergency switch (4) on the control board and its activation causes the immediate shutdown of all moving parts and the wash program.

The possibility of installing additional optional stopping devices in proximity of the basket entrance and exit is envisioned.

7.7 Display of temperatures

Reference fig. 6

The wash and rinse temperature values can be displayed at any time.

Just press the box on the right of the display (fig.6/A) during washing.

The main wash "**W2**", upper rinse "**B1**" and lower rinse "**B2**" water temperatures are shown on the display. (fig.6/A)

Press again to hide the message.

7.8 End run device

The machine must operate with a limit switch installed on the basket exit surface (see installation chapter).

The “Limit switch ON” and the **FC**  icon are shown on the display when a basket exiting the machine reaches the end of the surface and the drive system stops until the basket is removed.

Just remove the basket from the end of the surface to re-start the machine completely.

If the basket is not removed within a few minutes, the machine will switch off the rinse, wash, pre-wash and finally the drying areas in sequence, where installed.

7.9 Turning off and Standby of the machine

Reference figure 1

To turn off the machine, press the line button (1) which will turn red.

The display will remain on for a few minutes after which it will go off completely.

It is possible to lock the display during standby by pressing the button  and then reactivate it by









pressing the button .

This last function makes it possible to clean the display surface.

7.10 Adjustment

The user can adjust the temperatures and dosing times.

With reference to figure 7

- Access the adjustments menu by pressing the  icon (fig.7/A)
- Press the  icon to access the adjustment menu (fig.7/B)
- The access password  must be entered.
- Enter “0” ”1” ”2” using the   keys to change the number and the  key to move to the next
- Now, using the arrows, it is possible to display all temperature sets.
- To modify the parameter displayed, the menu key  must be pressed (the set box is highlighted) and using the   keys it is successively possible to set the desired value.
- Adjustments cannot be made with washing in progress.

7.10.1 Adjustment of temperature

Our settings are excellent for guaranteeing the best in terms of results, performance and consumption. In the case of specific requirements, it is possible to modify the factory-set temperature parameters into an adjustment range indicated below.

Program	WASH	SET in Factory	range of adjustment (°C)	
High capacity	P1 -Wash tank temperatures	63	Min. 0	Max. 70
General purpose	P2 -Wash tank temperatures	60		
Prolonged contact	P3 -Wash tank temperatures	60		
Intensive	P4 -Wash tank temperatures	63		
Glasses	P5 -Wash tank temperatures	60		

Program	RINSE	SET in Factory	range of adjustment (°C)	
High capacity	P1 -Boiler 1 rinse temperatures	82	Min. 0	Max. 90
General purpose	P2 -Boiler 1 rinse temperatures	82		
Prolonged contact	P3 -Boiler 1 rinse temperatures	82		
Intensive	P4 -Boiler 1 rinse temperatures	82		
Glasses	P5 -Boiler 1 rinse temperatures	65		
High capacity	P1 -Boiler 2 rinse temperatures	80		
General purpose	P2 -Boiler 2 rinse temperatures	80		
Prolonged contact	P3 -Boiler 2 rinse temperatures	80		
Intensive	P4 -Boiler 2 rinse temperatures	80		
Glasses	P5 -Boiler 2 rinse temperatures	65		

Program	PRE-WASH	SET in Factory	range of adjustment (°C)	
	Min. pre-wash temperatures	40	Min. 0	Max. 60
	Max. pre-wash temperatures	50		

Program	DRYING	SET in Factory	range of adjustment (°C)	
	Drying temperature	85	Min. 0	Max.100

Program	3rd TANK WASH	SET in Factory	range of adjustment (°C)	
	Tank 1 temperatures (where envisioned)	60	Min. 0	Max. 70

Program	SUPPLY	SET in Factory	range of adjustment (°C)	
	Supply water alarm temperature	10	Min. 0	Max. 65

7.10.2 Dosing devices

It is possible to adjust the dosing time of the rinse aid and detergent dosing devices in seconds.

	DETERGENT	SET in Factory	Range of adjustment (sec)	
	Detergent setting	4	Min. 0	Max. 25

	RINSE AID	SET in Factory	Range of adjustment (sec)	
	Rinse aid setting	3	Min. 0	Max.25





The dosing circuit can be loaded manually.

Select (using the menu key), “manual activation of the detergent dosing device” and/or “manual activation of the rinse aid dosing device” and then activate the function by indistinctly pressing one of the two keys or and the corresponding dosing device will start to load the circuit, for a pre-established time; press again if it is not sufficient to load the entire circuit.

7.11 Date and time adjustment

Reference figures 8 and 7

Access the adjustments menu by pressing the  icon (fig.7/A)

- Press the  key to access the adjustment menu. (fig.8/A)
- Press the start key 
- Change into hour, minutes, year, month and day sequence using the arrows  , confirming again using the return key 



The hour format can be changed by pressing the  key and the date by pressing the  key

Press the exit key  to go back to the previous menu.

7.11.1 Time adjustment

Reference figures 2 and 7

Access the adjustments menu by pressing the  icon (fig.7/A)

- Press the  key, to access the language selection menu and select that desired (fig.2/E)
- Press the exit key  to confirm the choice and go back to the previous menu.



7.11.2 Brightness adjustment and acoustic signal

Riferimento figura 7 e 9

Access the adjustments menu by pressing the  icon (fig.7/A).

Press the  key (fig 9/A).

Adjust the brightness of the display using the two keys   (fig 9/B).

Activate or deactivate the acoustic signal using the  key for off and the  key for on; successively press the exit key to confirm the selection and go back to the previous menu

7.11.3 System information

Reference figure 7

The firmware version installed can be demonstrated at any time.

Access the adjustments menu by pressing the  icon (fig.7/A).

Press the  key to access the screen indicating the firmware version installed.

Press the  key to exit.



7.11.4 Connectivity

The machine is set-up to be controlled from remote using wireless-type transmission.

A symbol present on the display, indicates whether the machine is connected to the wireless network or not

The  symbol indicates whether the machine is connected.

The  symbol indicates that the machine is disconnected.

To access the wireless network settings section, press the  key (fig.7/A) and then the  key to find out whether the machine is connected to the network or not.

Refer to the guide included in the optional wireless connection kit for further information

7.12 information menu

Reference figure 10

By pressing the "info" key , access is given to the information menu, from where it is possible to obtain accurate information regarding the error messages, the operating hours and main operating parameters (fig.10/A and 10/B), which are described successively.



7.12.1 Error messages

Reference figure 11

The machine has a self-diagnosis system and can inform the user of one or more malfunctioning messages.

By pressing the  key from the "info" menu, the last of the errors detected is displayed (fig.11/A and 11/B). Consult the "Self-diagnosis" paragraph to find out the meaning of the error message.



To find out the date and time of the event, press  (fig.11/B).



To scroll the error messages, press the  key; press the  key to exit the menu.

7.12.2 Operating hours display

Reference figure 12

Press the  key to display the partial or total wash and rinse operating hours.

By scrolling using the  and  keys, the partial and total wash and rinse times and the total machine switch-on times are displayed in sequence.



The partial counters can be reset by pressing the  key and confirming using the confirm key  or annulled using .

Press the exit key  to exit the menu.

7.12.3 Work functions display

Reference figure 13





The machine offers the possibility of displaying some operating parameters in detail by pressing the  key (fig.13/A).

It is possible to scroll the various sections of the menu by pressing the  key (fig.13/B-G); press the exit key  to go back to the previous menu (fig.13/H).

The following instantaneous operating temperatures will be indicated for each section:

- Inlet water temperature
- Water temperature of the two boilers
- Pre-wash tank water temperature
- Water temperature of the first and second wash tank if present
- Temperature of the drying air

Furthermore, several animated icons give further information for each section, such as:

- If the heating resistors are on, the thermometer icon flashes .
- If the machine is loading water, the tap icon shows a running flow .
- If drying is in progress, a flow of air blowing is displayed .
- The correct level of water in the tank is indicated by an arrow .

- The opening of the rinse solenoid valves with a flashing icon .

Rinse pump operation with a flashing icon .

7.13 Mechanical control panel

Reference figure 1

The machine has an additional panel, positioned at the exit of the machine's baskets, on which there are some basic controls and lights.

7.13.1 Voltage presence light

Reference figure 1

The light (7) indicates that the machine is electrically powered and it will remain on for the entire period in which the wall main switch is set to ON.

7.13.2 Exclusion of the touch display

Reference figure 1 and 5B

By turning the selector (8) clockwise, the touch keypad is excluded.

The display (3) will continue to show the parameters of the machine but it will no longer be possible to interact with it.

This condition is signaled by the continuous lighting of the warning light (5) and by the presence of the icon on

the display .

To re-enable the use of the display, simply turn the selector (8) anticlockwise.

7.13.3 Line push Button ON/OFF

Reference figure 1

In the condition of touch display locked (see previous paragraph) it will be possible to switch off and switch on the machine at any time by pressing the button (6).

When the machine is switched on again, it will start from the point and with the previously stored washing program.

7.14 Self-errors diagnosis

The machine is equipped with a self-diagnosis system that can detect and report different kinds of malfunctioning

Display	Error description and possible solutions	
Er01	Rinse not allowed	Switch the machine off and back on again after having checked that the overflow has been inserted correctly and the water supply has been opened. If the problem persists, contact the after-sales assistance centre
Er03	Thermostop time out	The boiler temperature has not reached the value set in the pre-established time, contact the after-sales assistance centre
Er04	Tank loading time-out	The correct water level in the wash tank is not reached. Switch the machine off and back on again after having checked that the overflow has been inserted correctly and the water supply has been opened. If the problem persists, contact the after-sales assistance centre
Er05	Tank probe "open"	The probe that measures the temperature of the tank is broken. Heating is prevented. Contact the after-sales assistance centre
Er06	Tank probe "closed"	
Er07	Boiler probe "open"	The probe that measures the temperature of the boiler is broken. Heating is prevented. Contact the after-sales assistance centre
Er08	Boiler probe "closed"	
Er13	Motors circuit breaker protection	Motors circuit breaker protection intervention, switch the machine off and contact the after-sales assistance centre
Er14	Drive system failure	Malfunctioning of the basket drive system; switch the machine off and contact the after-sales assistance centre
Er15	Drying probe "open"	The probe that measures the drying temperature is broken. Heating is prevented. Contact the after-sales assistance centre
Er16	Drying probe "closed"	
Er17	Water inlet probe "open"	The probe that measures the inlet water temperature is broken. Contact the after-sales assistance centre
Er18	Water inlet probe "closed"	
Er19	Pre-wash tank probe "open"	The probe that measures the pre-wash tank temperature is broken. Heating is prevented. Contact the after-sales assistance centre
Er20	Pre-wash tank probe "closed"	
Er25	Break tank load time out	The correct water level in the break tank is not reached. Switch the machine off and back on again after having checked that the water supply has been opened and that the water network flow rate is sufficient in compliance with that stated on the data plate. If the problem persists, contact the after-sales assistance centre
Er28	Pre-wash tank loading time-out	The correct water level in the pre-wash tank is not reached. Switch the machine off and back on again after having checked that the overflow has been inserted correctly and the water supply has been opened. If the problem persists, contact the after-sales assistance centre
Er30	Boiler 2 probe "open"	The probe that measures the temperature of boiler 2 is

Er31	Boiler 2 probe "closed"	broken. Heating is prevented. Contact the after-sales assistance centre
Er32	Tank 2 probe "open"	The probe that measures the second wash tank temperature is broken.
Er33	Tank probe "closed"	Heating is prevented. Contact the after-sales assistance centre

Warning:

When the machine is switched off and then on, the alarm is initially reset, but will be displayed again if the cause of the problem is not solved.

7.15 End of washing operations

With reference to Figure 17

- Stop the machine using the line button (Fig. 17/A)
- Switch off the wall-mounted main switch (Fig. 17/B)
- Open the doors, making sure they are firmly hooked to their supports. (Fig. 17/C)
- Remove the horizontal filters, being particularly careful so as not to drop residues of food inside the washing tank. (Fig. 17/D)
- Lift the vertical filter and dispose of its contents. Use a hard brush to rinse the horizontal and the vertical filters. (Fig. 17/D)
- Slide out the overflow and allow the tank to drain. (Fig. 17/F)
- Accurately wash the bottom of the tank with a jet of water.
- Accurately wash the curtains.
- Remove any traces of dirt from the empty tank. At this point only, remove the safety filter of the pump and wash it under running water. (Fig. 17/G)
- The external parts of the machine must be cleaned when their surfaces are cool, using a sponge and non-foaming products that must be neither acid nor abrasive.
- Reinsert the overflow devices, the safety filters and the tray filters.

The machine is now ready to use.

WARNING: Do not wash the machine with water streams or high-pressure water directly applied to it, as any leaks into the electric components may compromise the regular function of the machine and of its safety systems, annulling the warranty.

It is advisable to leave the doors open, to avoid the formation of unpleasant smells.

7.16 Positioning the dishes

With reference to figures 14,15 and 16

- This dishwasher is designed for washing plates, glasses, flatware, kitchen utensils, trays and small containers, always using specific 50x50 cm baskets which must be correctly loaded.
- Place cups and glasses upside down in the flat baskets. Stem glasses must only be washed in baskets with dividers which can be purchased separately fig. 14
- Place plates in the plate basket specifically designed with support shafts, with the inner surface facing upwards fig.14.
- Place flatware and teaspoons in the cutlery basket with the handles pointing downwards. Wash the various types together for optimum wash results fig.14.
- Trays and chopping boards of a maximum size of 530x325x60 mm (gastronorm 1/1) may be washed, using specific baskets without sides and inserts, loading them lengthwise in the direction of machine travel fig.14 and 15

Recommendations:

- Do not wash silver and stainless steel flatware in the same cutlery basket as this will tarnish the silver and may corrode the stainless steel.
- Always use the specific baskets designed for the various types of item to be washed (plates, glasses, cups, flatware, trays etc.) fig. 14.
- To save both detergent and electricity, only wash full, but not overloaded, baskets.
- Avoid overlapping items.
- To minimise maintenance, **we recommend** pre-cleaning items to be washed by removing left-over food particles such as fruit peel plus toothpicks, olive pits etc, which could otherwise partly clog the filter of the electro-pump, reducing wash performance and negatively affecting the quality of the final results fig.14.
- It is advisable to wash the dishes before food particles dry onto the surface. In the event of dried-on food residue, dishes and flatware should be left to soak before being put in the machine
- Always select the wash programme and/or speed best suited to the type of items to be washed
- Always wash glasses with clean wash water and, if possible, at the start of the shift or after changing the water. Use the glasses cycle available on some models.
- To wash crystal glassware, only use baskets with special compartments and water with conductivity below 80 μS
- If a corner configuration pre-wash is present, the trays must be loaded with any protruding parts facing the direction of travel Fig.16
- The machine is not designed for the continuous washing of predominantly large-sized items. The latter may nonetheless be washed, in between the washing of other dishes and using suitable baskets with tray supports.
- The machine is not designed for washing baskets.
- Incorrect loading or washing of large-sized items, for which the machine is not designed, may lead to abnormal leaks into the drain, resulting in the partial emptying of the tanks. In this case, the machine stops automatically and proceeds to refill with water until the correct level is restored. This may occur several times over the course of service.
- The baskets must be of a type suitable for the dishwasher's conveyor system and must be in good condition, especially on the bottom. Use the baskets in the machine's equipment as a reference.
- In the case of machines with corner configuration drying, trays must be placed in the dedicated basket, leaving one out as illustrated in figure 15
- Baskets sized 50x60 cm cannot be used.

Cap 8 MAINTENANCE○ **General rules**

The machines are designed to minimise the need for maintenance. Carefully observe the rules below to ensure the long working life of the machine and trouble-free operation.

In any case, there are a few general rules to follow to keep the machine in perfect working order:

- keep the machine clean and tidy
- avoid allowing temporary or urgent repairs to become a matter of routine

Strict observance of routine maintenance rules is extremely important; all machine parts must be regularly checked to prevent problems and malfunctions from arising, thus reducing the time required for any maintenance interventions.

Warning!

- Before cleaning operations, disconnect the appliance from the power supply
- Before cleaning, wear gloves with a minimum cut protection of 3 in accordance with EN388.
- Cleaning the machine with products that contain chlorides in a concentration exceeding 50 ppm can lead to corrosion of the machine's stainless steel structure.

8.1 Periodical maintenance

With reference to Figure 18

Attention!

Before carrying out the following operations, wear gloves with a minimum cut protection of 3 in accordance with EN388.

- Disassemble the upper and lower rinsing arms.
- Clean all nozzles, removing any obstruction found, and reassemble them.
- Disassemble the curtains and clean them with a nylon brush under running water.
- Disassemble the upper and lower washing arms and rinse them.
- Remove the washing pump filter and rinse it.
- Clean the washing tank thoroughly.
- Due to the calcium and magnesium salts present in the water, after a certain period of operation, which varies according to the hardness of the water used, a calcareous layer deposits in the inner surfaces of the boiler tank and of the pipes, compromising the proper functioning of the machine.
- It is therefore necessary to periodically remove incrustations, an operation that should be carried out by technically qualified personnel.
- If the machine is to be left unused for a long period of time, the steel surfaces must be greased with Vaseline oil.
- If there is danger of water freezing, have technically qualified personnel drain the boiler water and the washing pump water.
- If intense calcareous deposits form inside the machine in the presence of water, use an incrustation removing product.
- To remove the incrustations, carefully follow the instructions of the manufacturer of the product, or seek the assistance of qualified personnel. In any case, always rinse the machine thoroughly after removing incrustations.
- Make sure the safety devices are working efficiently.
- If the steam condensing battery is dirty, disassemble it and clean the spaces between the flaps using compressed air.

- **REMINDERS:**

Every mechanical and electromechanical part of the machine is subject to physical wear. A qualified technician must carry out periodical inspections on:

- Conveying system sledges
- Washing/rinsing electro-pump seals
- Door guides and springs
- Remote control switch
- Safety devices

In addition, it is obligatory to test and inspect the devices that are not part of the machine, such as earthing differential, proper earthing, automatic switches and/or fuses in the power line, every electric conductor, the status of water pipes, discharge system, proper functioning of dispensers.

- **In case of malfunctioning, seek only technical assistance centres authorised by the manufacturer or by the manufacturer's dealer.**

**Cap 9 DISPOSAL**

Our machines do not contain any material that requires particular disposal procedures. (Applicable in European Union countries and in countries with selective waste collection) The marking on the product or on its documents means that the product must not be disposed of as domestic waste at the end of its working life. To avoid damages to the environment or to the health due to the incorrect disposal of waste, users should separate

this product from other kinds of waste, and recycle it responsibly to promote the sustainable reuse of material resources.

Domestic users should contact their dealer, or the local office in charge of providing information regarding selective waste collection and recycling options for this kind of product.

Corporate users should contact their supplier and verify the terms and conditions of the purchase contract. This product must not be disposed of with other commercial waste.

Cap 10 ENVIRONMENT**ENVIRONMENTALLY SAFE USE**

- A conscious use of the dish washer may help reduce environmental impact, simply by following a few indications in every day use, such as:
- Only wash fully loaded baskets.
- Switch the dish washer off when not in use.
- Keep the machine closed when in stand-by mode.
- Use programmes suitable for the level of dirt.
- Supply the machine with hot water, if the water is heated with gas.
- Make sure that the drained water is conveyed to suitable sewage system.
- Do not exceed the recommended detergent doses.

The manufacturer is entitled to carry out electrical, technical and aesthetic modifications to the machine, and/or to replace parts without previous notice, whenever deemed necessary, in order to offer a reliable, long-lasting product with advanced technology.

The manufacturer is entitled, according to the property law described in this document, to forbid this document from being reproduced and made public through any means without the manufacturer's express written authorisation.

The manufacturer is entitled to modify this document whenever necessary, in order to improve it.

