

















	Model	toptech 32-23D.7 NRG	
	Code Production	LP723RCDDD	
Interface :			



	Äußere Abmessungen (Breite-Tiefe-Höhe) *offen	mm	1465x857(*1400)x2187(*2274)
	Verpackungsmaße (BxTxH)	mm	1750x1100x2200
	Bruttogewicht	Kg	343
	Nettogewicht	Kg	327
	Volumen	mc	3,85
	Korbgröße	mm	1320x700
	Maximale Türöffnung	mm	850
	Maximal nutzbare Höhe	mm	800
	Gehäusekonstruktion		doppelwandig
	Tür/Haubenkonstruktion		doppelwandig
	Tankkonstruktion		tiefgezogen
	Tankvolumen	liter	131
	Tankheizung	W	10.500
	Tankflächensieb		Edelstahl
	Spülpumpentyp		doppelflutig
	Spülpumpenleistung	W	2 X 2.700
	Spültemperatur	°C	55 (55-65)
	Boilertyp		drucklos
	Boilervolumen	liter	17
	Rückflussverhinderer		freier Auslauf
	Boilerheizung	W	10.500
	Nachspülpumpe		ja
	Nachspülpumpenleistung	W	200 x 2
	Nachspültemperatur	°C	80 (80-85)
	Wasserverbrauch der Nachspülung	Liter /Korb	6
	Optimaler externer Wasserdruck	bar	1 - 6
	Ablaufsystem		teilentleerung
	Ablauffilter		Doppelfilter
	Ablaufpumpe		Standartmäßig eingebaut
	Klarspülmitteldosierer		ja
	Reinigerdosierer		ja
	Zyklusdauer	Sekunden	120 - 240 - 360 - 720
	Sonder-Zyklen	Programme	n°6
	Selbstreinigungszyklus		ja
	Wärmerückgewinnung (elektrische Leistung)	W	50
	Wärmerückgewinnung (Luftdurchfluss)	m³/h	680
	Wärmeabgabe Sensibel	KW	1.2
	Wärmeabgabe Latent	KW	1.6
	Gesamtanschlußwert	W	15.900
	Stromanschluß	V - ph - Hz	400V 3N 50Hz
	Absicherung	A	32
	Edelstahlkorb	n°1	43305

Anschlusskabel	ja
Zulaufschlauch	ja
Ablaufschlauch	ja

A		∅ 50mm M	A		∅ 32 mm M
B		G 3/4" M	B		G 3/4" F
C		Power supply	E		Steam exhaust

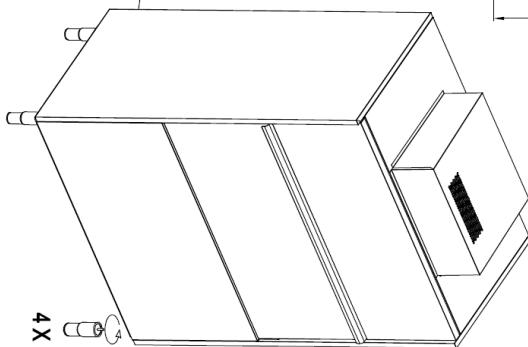
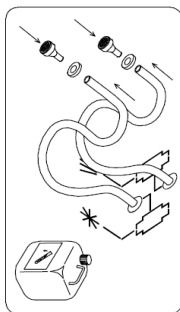
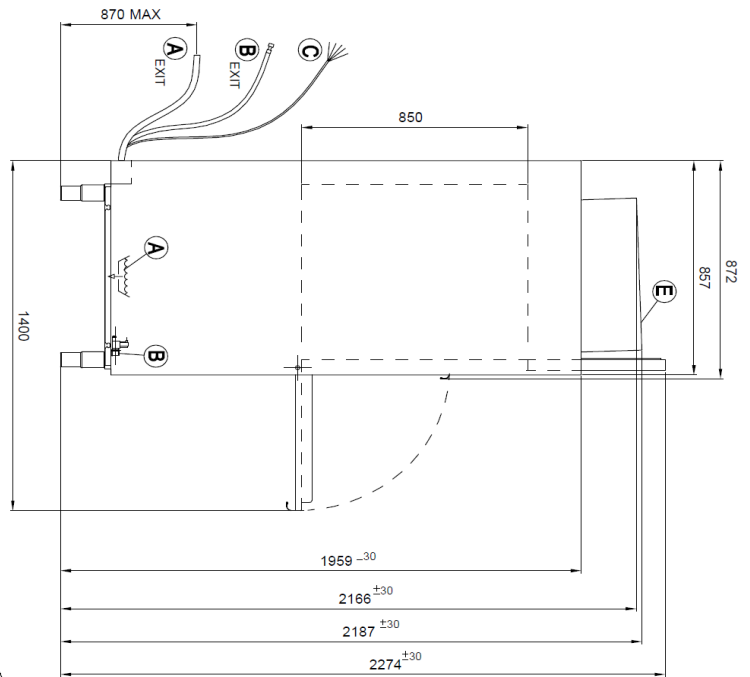
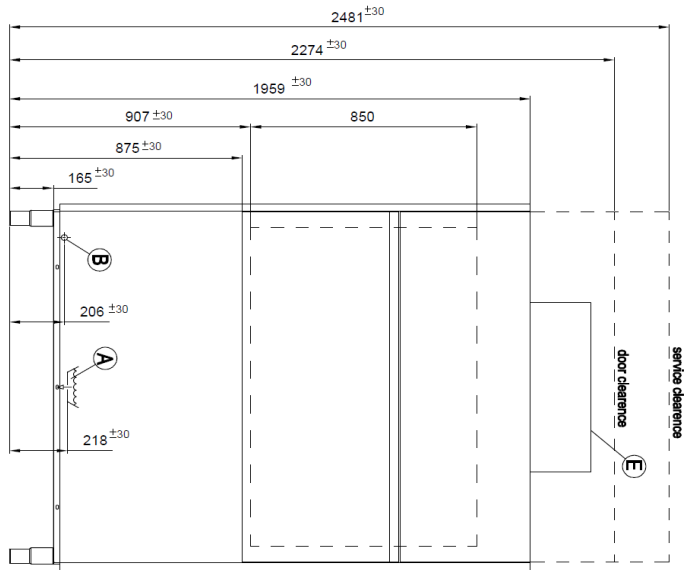
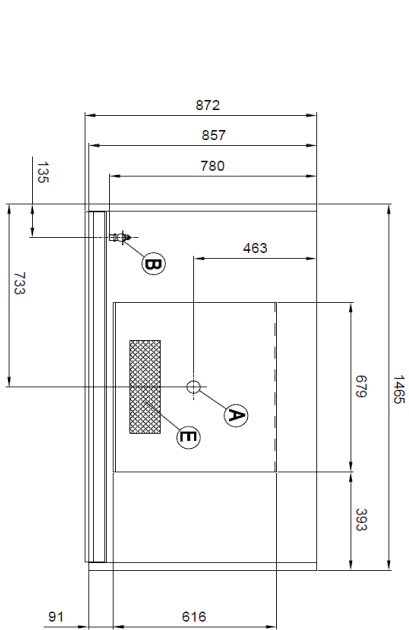

Designed by: M. PIERI Date: 12.10.2018
Installation layout
 Denomination: Utensil washer NRG, Drain P.
 Code: LPTRSP 00
 Rev.:

